



ILICA

NEWS

Land Improvement Contractors Of America · Illinois Chapter

March - April 2024

Past President

Steve Anderson

President

Eric Layden

Vice President

Jon SeEVERS

First Vice President

Tyler Seals

Treasurer

Lee Bunting

Associate Director

David Randolph

Executive Director

Ryan Arch

Directors

Area 1

Brian Brooks
LaVerne Weber

Area 2

Steve Anderson
Stuart Anderson

Area 3

Joe Streitmatter
Grant Curtis

Area 4

David Kennedy
Lee Bunting

Area 6

Bill Dean
Scott Day

Area 8

Tom Beyers
Tyler Seals



ILICA ANNUAL CONVENTION TIPS THE HAT TO IOWA

(page 14)



2023 ILICA AWARD RECIPIENTS

(page 16)



CHANGE PROMULGATED AT NATIONAL LICA CONVENTION

(page 20)

Also Featured Inside:

- ▶ **2024 LICA Scholarship Application** *(page 9)*
- ▶ **Extension Connection: Using Solar Energy to Enhance Denitrification in Woodchip Bioreactors During Winter** *(page 12)*

Illinois LICA
112 Exchange St., Ste. 2
Galva, IL 61434



**WE'RE WITH YOU IN THE
TRENCHES.**

SPRINGFIELD PLASTICS, INC. IS RIGHT THERE WITH YOU to ensure every job goes smoothly and the quality of our drainage tile lines up with the high quality of your work.

Only Springfield Plastics uses **100% VIRGIN RESIN** in our tile, so you can count on the highest-quality, most consistent tile available.

**HEAVY, DURABLE
TILE AND FITTINGS**

**NO CRACKS, SOFT SPOTS,
OR BLOWOUTS**

**INTEGRITY
THROUGHOUT THE PIPE**

For a drainage tile supplier that will support you through the entire project, talk to Springfield Plastics.



800-252-3361 • spipipe.com

Schlatter's Inc.
Intelligent Water Management™



Drainage Plows
GPS Machine Control
Design Software
Custom Fabrication



Since 1952 16179 W 500 S
Francesville, IN 47946
(219) 567-9158
www.SchlattersInc.com



OUR NEW CATALOGS HAVE ARRIVED!



**THE COMPLETE LINE
OF HICKENBOTTOM®
PRODUCTS**

REQUEST YOUR COPY ONLINE AT HICKENBOTTOMINC.COM OR CONTACT YOUR LOCAL DEALER



The ILICA News



Editor / Advertising Manager
Ryan Arch

Past President
Steve Anderson, Marseilles

President
Eric Layden, Hoopeston

Vice President
Jon Seevers, Argenta

1st Vice President
Tyler Seals, Mt. Carmel

Executive Secretary
Ryan Arch, Galva

Treasurer
Lee Bunting, Dwight

Educational Advisor
Professor Richard Cooke
University of Illinois

The *ILICA News* is the official publication of Illinois Land Improvement Contractors Association, Inc. at 112 Exchange St., Ste. 2, Galva, IL 61434. (309) 932-1230.

Subscription price is \$50.00/year, issued bi-monthly: Jan.-Feb.; Mar.-Apr.; May-June; July-Aug.; Sept.-Oct.; Nov.-Dec., and also includes one annual directory.

FEATURES

- Membership Honor Roll 6
- 2024 LICA Scholarship Application 9
- ILICA Annual Convention Tips the Hat to Iowa 14
- 2023 ILICA Award Recipients 16
- Change Promulgated at National LICA Convention 20

COLUMNS

- President's Message 4
- 2024 Board & Members' Meeting Schedule & Attendance 4
- New Members 5
- ILICA Ladies' Page: Quick and Easy Easter Bunny Treat Jars 8
- Extension Connection: Using Solar Energy to Enhance Denitrification ... 12
- ILICA Trivia 22
- Calendar of Events 23
- Advertiser Index 23
- Featured LICA Benefit: Special BigIron Member Auctions 24
- Safety Feature: Defensive Driving Tips 26

Northland Trenching Equipment, LLC

"We are the largest volume supplier for this type of equipment in the US"

 **TRIMBLE GPS SYSTEMS**



The Inter-Drain plow, three types, double link, single cantilever, or single link, each in three sizes. Cat, Cummins or Volvo power. Offset available.



**Inter-Drain
Plows & Trenchers**



The Inter-Drain chain trencher. Four size choices, mechanical or hydraulic chain drive, vertical and offset available. Cummins, Volvo or Cat power.

 **FULL SERVICE AND REBUILDS**

 **HUGE PARTS INVENTORY**

Corporate Office
12929 410th Avenue
Waseca, MN 56093
Phone: (507) 835-4214
Fax: (507) 835-2032

Eastern Division - Indiana
3578 North State Road 59
Brazil, IN 47834
Phone: (812) 835-2900
Fax: (812) 835-2535

Email: nte@hickorytech.net
www.northlandtrenching.com



PRESIDENT'S MESSAGE



Greetings again. I waited until the publication deadline this time around to write this newsletter message. The reason why is that just yesterday I arrived home from the Land Improvement Contractors of America's national winter convention and members' meeting held in Virginia Beach

this year. I wanted to be able to report directly back to you all about what is happening on a national level. I can report that LICA is growing by two new state chapters, Tennessee and Texas. Eileen Levy, National LICA's Executive Director, often referred to as "Mother LICA," is retiring after dedicating 40 years to the organization. I wish her a happy and long retirement. National LICA is prepping for a six month membership drive where they hope to gain at least 200 new members nationally, and they are going to expect Illinois to do our part in this effort. If you know anyone in your area that could benefit from a membership to LICA and ILICA, please reach out to our state office. We can send free membership packets to you or directly to them; just let us know.

Speaking about ILICA, I want to thank all the contractor members and associate members that attended Illinois's state winter convention and members' meeting held this past February at the Isle Casino Hotel. Our feedback from those that attended was very positive. We keep improving on the convention every year with a variety of entertainers, huge trade show, and industry specific education sessions. This year brought ILICA contractor members face to face with the leaders of JULIE, Ameren, and Marathon Pipe Line after a gas pipeline strike occurred and a number of our very own members nearly lost their lives due to the utility no mark. Utility locating is part of land improvement. If you are moving soil, you must have a utility locate filed. There is no exception. These contractors had called JULIE (811) for a utility locate. The gas pipeline was just not located. Illinois LICA will be seeking a seat on the state board of JULIE (811) in the near future. This is a position that a representative of Illinois LICA has held in the past. We hope to restore that, especially since all current board members of JULIE are industry insiders and not contractors.

On a national and state level, we realize that we are not going to get all members to our events, no matter how awesome the entertainment is, how big the trade show is, or how important the educational topics are. It doesn't even matter if the event is close by. ILICA recognizes that we need an even bigger social media presence. Expect to see more webinars, YouTube videos you will learn something from, and more online content from us soon.

At home here, we are busy getting the fleet ready for a smooth spring season. I wish you all a productive and safe spring. I thank you again for your membership to ILICA. We are working hard to keep creating more and more value for your membership. Expect more from us soon, and never think we won't come to bat for you. Locating utilities is a perfect

example. We expect more, and we are going to push for improvements. Why? Well, for many reasons, but first and foremost because a member like you brought it to our attention. I leave you with the best of wishes for you, your family, and crew.

Best regards,
Eric Layden

2024 BOARD MEMBER MTG. ATTENDANCE						
	A = absent	P = present			C = cancelled meeting	
Area / Director	Jan	March	May	June	Sep	Nov
Pres: Eric Layden	P					
VP: Jon Seevers	P					
1st VP: Tyler Seals	P					
Area 1 - Brian Brooks	P					
Area 1 - LaVerne Weber	P					
Area 2 - Steve Anderson	P					
Area 2 - Stuart Anderson	P					
Area 3 - Grant Curtis	A					
Area 3 - Joe Streitmatter	P					
Area 4 - David Kennedy	A					
Area 4 - Lee Bunting	P					
Area 6 - Scott Day	P					
Area 6 - Bill Dean	A					
Area 8 - Tom Beyers	P					
Area 8 - Tyler Seals	P					
Associate Director: David Randolph	P					

BOARD & MEMBERS' MEETING SCHEDULE

Unless changed by the Board during the year, the ILICA business meetings are scheduled as follows:

March 9, 2024 - Regular Meeting of the Board:
Museum of the Grand Prairie, Mahomet

Exact location, meeting times & other details will be published in the ILICA News and sent to members via mail and/or email.

NEW MEMBERS

Contractors

William Schrage

WRS Construction

436 E 1800 North Rd.

Monticello, IL 61856

Ph: 217-418-54655

Email: william@buildwithwrs.com

Clinton Green

Green Acres Outdoor Services

8963 E. Kirsch Rd.

Troy, IL 62294

Ph: 618-667-4225

Email: greenacres1985@att.net

Bob Behm

Behm Enterprises, Inc.

431 Scotland Rd. Unit A

Lakemoor, IL 60051

Ph: 815-344-0197

Email: bob@behment.com

Website: behment.com

Austin Wissel

Wissel Trucking, Inc.

25945 Dee Mack Rd

Washington, IL 61571

Ph: 309-208-2628

Email: austinwissel@yahoo.com

Zach Slatton

Slatton Outdoor Services, Inc.

745 US Route 40

Pocahontas, IL 62275

Ph: 618-781-7818

Email: slattonoutdoorservices@gmail.com

Associates

IH Mississippi Valley Credit Union

Justin Johnson

2500 River Drive

Moline, IL 61265

Ph: 309-762-8776

Email: jjohnson@ihmvcu.org

Illinois Sustainable Ag Partnership

Helen VanBeck

1108 Trinity Lane

Bloomington, IL 61704

Ph: 872-250-8771

Email: hello@ilsustainableag.org

Website: ilsustainableag.org

HyPro Equipment

Delton Frey

325531 Durham Rd. B

Priceville, Ontario, N0C 1H0

Ph: 519-505-6636

Email: sales@hyproequip.com

Website: hyproequip.com

Legacy Equipment Co.

Jake Nicholson

29689 Lakeland Rd

Deer Creek, IL 61733

Ph: 309-645-5065

Email: legacyequipmentco@gmail.com

Website: oconnelldrainage.com

Illinois LICA's 2024 Honor Roll

50 years

Ronald, David, Edwin & Jeffrey Lilja -
Lilja Tiling & Excavating
Jerry & Mike Nelson - J.L. Nelson Construction Co.

25 years

Donald Bunting - Bunting Brothers
Lee Bunting - Bunting Brothers
David Lake - Lake Contracting

20 years

Bob Prose
Vincent Earthmoving

15 years

Brent Breedlove - B.E.B. Excavating
Dennis Brooks, Sr. - D. Brooks Excavating
Matt Froese - Froese, Inc.
Steve Jurgens - Precision Drainage Systems
Jeff Kocher - C.F.C.O., Inc.
Travis Miller - Miller Excavating
Sam Wettstein - The Hole Deal
Mike Yordy - Mike Yordy Excavating

10 years

Duane Beyers - Seventh Son Excavating
Wayne Bollin - Bollin Tiling and Earthmoving
James Burke, Sr. - J.M. Burke, Inc.
Brian Frederick - Frederick's Pioneer Electric
Ralph Gensini, Jr. - Gensini Excavating
Tony Miller - Miller Tiling Co.
Ryan Moore - LRS Farm Drainage
Ryan Point - Accudrain
Joshua Probyn - Probyn Trucking & Excavating

5 years

Jeffrey Beyers - Beyers Construction Co.
Will Dalenberg - Dalenberg Farm Drainage
Adam Gilbert - Gilbert Farm Drainage
Tom Huddleston - Huddleston McBride Drainage Co.
Randy McClintock - McClintock Trucking & Excavating
Craig McCoy - McCoy's Trenching & Excavating
Ron Woodrum



LAYING THE GROUNDWORK FOR TOMORROW

Your reputation is on the line with every job you do. For 100 years, we've held ourselves to the same standard.

When your tomorrow depends on a pipe you can trust, count on Fratco for the quality drainage products you need.

FRATCO

FRATCO.COM/100



ILICA Ladies' Page

These cute Easter mason jars are a sweet way to deliver a little bit of springtime cheer to your loved ones! Fill them with candy, fresh flowers, a DIY candle or homemade sugar scrub for a quick and easy gift idea that's sure to be a huge hit!

SUPPLIES USED FOR EASTER BUNNY MASON JARS:

- Pint-Sized Mason Jars
- Removable Adhesive Vinyl and an Electronic Cutting Machine (I recommend the Cricut Maker or Silhouette Cameo)*
- Chalky Finish Paint or Spray Paint
- Assorted Ribbon and/or Lace for Trim
- Flower Mason Jar Lid, optional

* Note: If you don't have an electronic cutting machine, you can also purchase vinyl bunny stickers!

HOW TO MAKE EASTER BUNNY TREAT JARS:

1. Start with clean glass mason jars and vinyl stickers. Apply the stickers to the smooth side of the jar, pressing firmly on the edges to make sure they completely adhere to the glass.



QUICK AND EASY
EASTER BUNNY
TREAT JARS
HAPPINESSISHOMEMADE.com

2. Apply a coat of Chalky Finish paint to the jars, painting over the vinyl stickers as well.

3. Allow the paint to dry for 2 minutes and then carefully peel up the vinyl stickers while the paint is still slightly wet. (Note: Spray paint will also work; however, when using spray paint, make sure to paint the jars upside down so that no paint gets inside of the jar!)

4. Add a ribbon or some lace trim, and it's all ready for gifting. Easy peasy!

There are so many ways that you can use these cute Easter treat jars! They would make a lovely hostess gift for Easter festivities or a super sweet teacher gift as you head into Spring Break! No matter how you decide to use these (whether you gift them away or keep them to decorate your own home!), they're always a huge hit!

Source: Reprinted with permission from Heidi Kudin, Happiness is Homemade - <https://www.happinessishomemade.net/easter-bunny-treat-jars/>

Agri Drain

CORPORATION

America's Most Complete Manufacturer & Supplier of Water Management Products

Call for a **FREE** catalog or visit our website to view our full line of products.

800-232-4742 ■ 641-742-5211 ■ www.agridrain.com

Watermaster Floating Pump

Intake Marker Flags

Bar Guards

Catch Basins

Smart Drainage System®

Flap Gates

2024 LICA SCHOLARSHIP APPLICATION

Every year, National LICA awards scholarships to support students in their pursuit of higher education. LICA encourages students to fulfill their dreams of entering into the career of their choice.

To be eligible, applicants must be related to an active LICA Contractor member. This includes members themselves,

spouses, children or grandchildren. To apply, complete the application **no later than March 15, 2023** and return to:

National LICA, 3080 Ogden Ave., Ste 300, Lisle, IL 60532

Applications can also be downloaded online at: <https://www.licanational.com/national-scholarship/>



National Land Improvement Contractors of America Scholarship Application

3080 Ogden Ave. Suite 300; Lisle, IL 60532
Phone: (630) 548-1984 • Email: NLICA@aol.com

Name: _____ Age: _____

Address: _____

City/State/Zip: _____

Phone: _____ Email: _____

Educational institution currently attending: _____

Present year in school: _____ Major course of study: _____

List courses you are taking or planning to take: _____

Parent or Guardian: _____

Address: _____

City/State/Zip: _____

Occupation(s) of parent(s) or guardian(s): _____

Name of current, active LICA contractor member: _____

Relationship to active LICA contractor member: _____

Instructions:

- 1) Write an essay (300 words or less) describing your academic, vocational and personal goals and objectives and why you should receive this scholarship.
- 2) List your major course of study and include high school and/or college grade transcripts.
- 3) Include three letters of recommendation from your community, school or other adult non-relative.
- 4) Include a wallet size picture (2"x3" or equivalent), with the understanding that award recipients will be featured in the *LICA News*.
- 5) Application must be completed and mailed to the National LICA office with a **postmark date no later than March 15**. Incomplete applications and ineligible students are automatically disregarded.

Applicant's signature: _____ Date: _____



www.PortIndustries.com

(573) 769-3338

HydramaxxSales@portind.com



Quality Products...Unequaled Service

Over 65 years of manufacturing and supplying corrugated metal pipe and related highway drainage products.

Havana, IL Office (309) 543-2271

Monmouth, IL Office (309) 734-4113

Corporate Office (800) 735-7312

Email: sales@metalculverts.com

www.metalculverts.com

www.wmsag.com

Agricultural and Drainage Engineering Services for Drainage Districts, Farmers, and Rural Landowners.

Reasonable, realistic engineering solutions for farmers and landowners throughout IL by a farmer, landowner, and drainage engineer.



Stephen M Anderson, PE
Water Management Solutions LLC
10158 E Lakeside Road
Effingham, IL 62401
217.821.3559
stephen@wmsag.com

1807 179th St North
East Moline, IL 61244
(309) 751-9540

120 East Martin Dr
Goodfield, IL 61742
(309) 965-3300



WWW.VERMEERMIDWEST.COM

Bulk mulch available!

309-654-2261
www.xylemltd.com
 Cordova, IL 61242

XYLEM^{LLC}

Quality wood chips for bioreactors!

ROLAND MACHINERY CO.
www.rolandmachinery.com

FOR ALL OF YOUR EQUIPMENT NEEDS!

CHOOSE ROLAND
 RELIABLE EQUIPMENT • RESPONSIVE SERVICE
 REPAIR PARTS IN STOCK

Illinois locations

Springfield, IL 816 N. Dirksen Parkway Springfield, IL 62702 Phone: 217-789-7711	East Peoria, IL 4299 N. Main St., Unit A East Peoria, IL 61611 Phone: 309-694-3764
Bolingbrook, IL 220 East Frontage Rd. Bolingbrook, IL 60440 Phone: 630-739-7474	Cartersville, IL 1505 Donna Drive Cartersville, IL 62918 Phone: 618-985-3399
Marengo, IL 18210 Beck Road Marengo, IL 60152 Phone: 815-923-4966	

KOMATSU **KOMATSU** **WIRGTEN** **HAMM** **KLEEMANN** **VÖGELE**
TANA **OBADALI** **DOOSAN** **Leibny** **Nasco** **Epiroc**

BRADFORD SUPPLY COMPANY
WWW.BRADFORDSUPPLYCOMPANY.COM

ALUMINIZED CULVERTS
 6" - 108" DIAMETER

HDPE CULVERTS
 4" - 60" DIAMETER

- Drain grates
- Plastic field tile
- Rodent guards
- Landscape fabric
- PVC pipe & fittings
- Road underlayment
- Silt fencing and stakes
- Straw blankets and wattles
- Single/ Dual wall poly culverts
- Aluminized steel culverts & aprons
- Structural Steel Tubing and Casing

MARKETS SERVED
 OILFIELD • PLUMBING • WATER WELL • INDUSTRIAL • AGRICULTURAL
 ONSITE WASTEWATER • LAND IMPROVEMENT

LOCATIONS

Robinson, IL (618) 544-3171	Bloomington, IL (309) 828-8313	Princeton, IN (812) 385-3431	Salem, IL (618) 548-0364
Carmi, IL (618) 382-5851	St. Elmo, IL (618) 829-3240	Bridgeport, IL (618) 945-2611	Clay City, IL (618) 676-1166
Sterling, IL (815) 625-0937	Decatur, IL (217) 429-9216	Grayville, IL (618) 375-4441	New Harmony, IN (812) 682-3250
Henderson, KY (270) 827-1142	Gaylord, MI (989) 731-9996	Powell, WY (307) 754-5767	Riverton, WY (307) 856-1355

USING SOLAR ENERGY TO ENHANCE DENITRIFICATION IN WOODCHIP BIOREACTORS DURING WINTER

By Jason Kandume & Richard Cooke

The intensification of agricultural food production in the Midwestern USA had led to daunting challenges to achieve agricultural sustainability. One of the concerns in agricultural operations is water containing nitrogen (N) and phosphorus (P) entering tile drains, which, when released from fields, can degrade water quality.

To reduce nitrate loads from agricultural fields in Illinois, the Illinois Nutrient Loss Reduction Strategy and Nutrient Reduction Strategy Policy Working Group have developed strategies and management practices based on science and best-available technology to target the state's most critical watersheds. For nitrate from tile drainage, the use of woodchip bioreactors is one of the recommended practices. They are relatively inexpensive, reliable, require low maintenance, and easy to install. Researchers at the University of Illinois have been at the forefront of the characterization of bioreactor performance and developing design standards.

Despite woodchip bioreactors showing promise in reducing nitrate loads from agricultural drainage water, the challenge of relatively low removal performance of these bioreactors under low-temperature conditions during the winter season remains hard to overcome. The performance of the woodchip bioreactor during winter needs to be improved, especially in terms of increasing system temperature, which is a key element in bioreactor performance. In Illinois a large percentage of annual drain flow occurs in winter and spring. Research is being conducted to enhance nitrate removal from the bioreactor in these colder months.

The layout of a system on the university's South Farm for testing the effectiveness of heated bioreactors is shown in Figure 1. Water from the field is channeled into two bioreactors, one of which the water is heated. The water is heated by pumping water from the outlet structure through chambers heated by parabolic solar energy concentrators and returning the water into the inlet manifold. The pump is powered by solar energy. The system is instrumented to cap

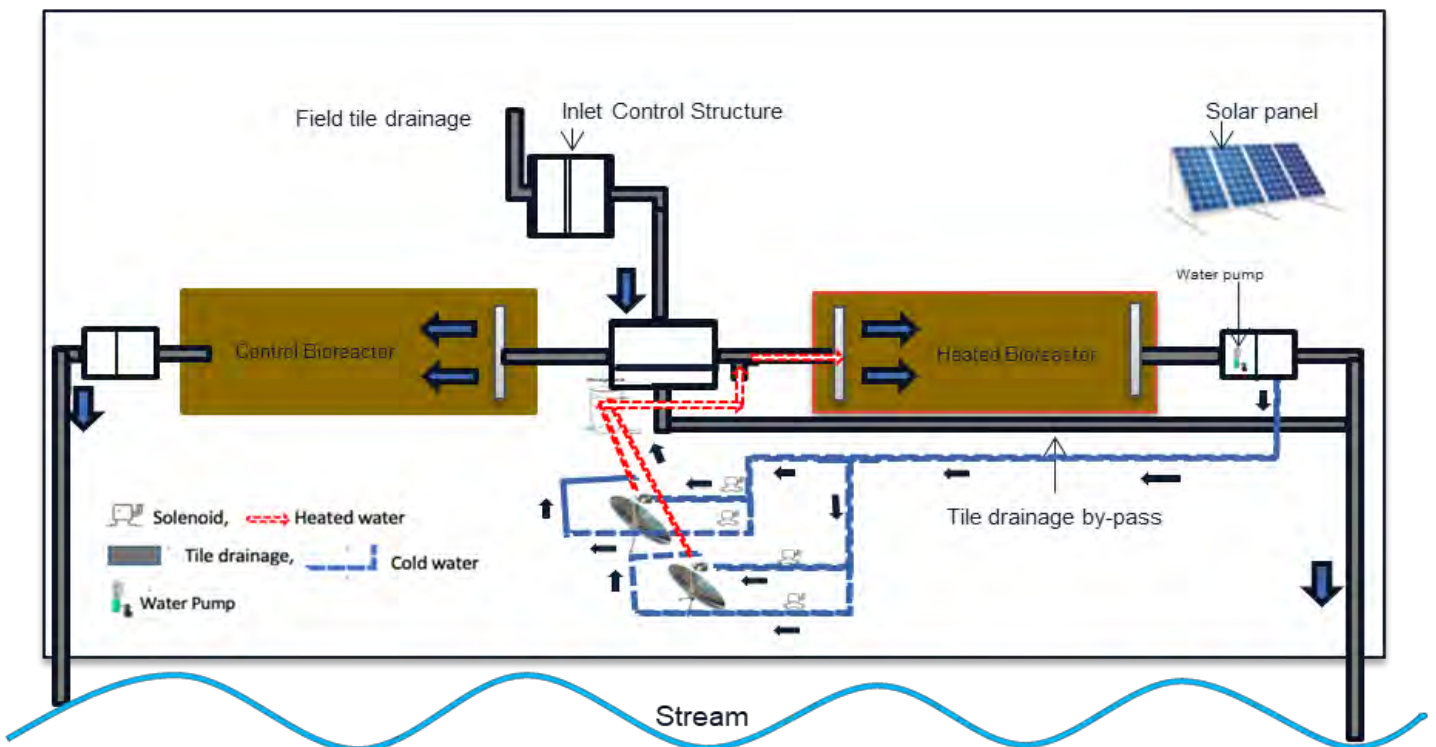

Figure 1. Schematic of heated bioreactor installation.

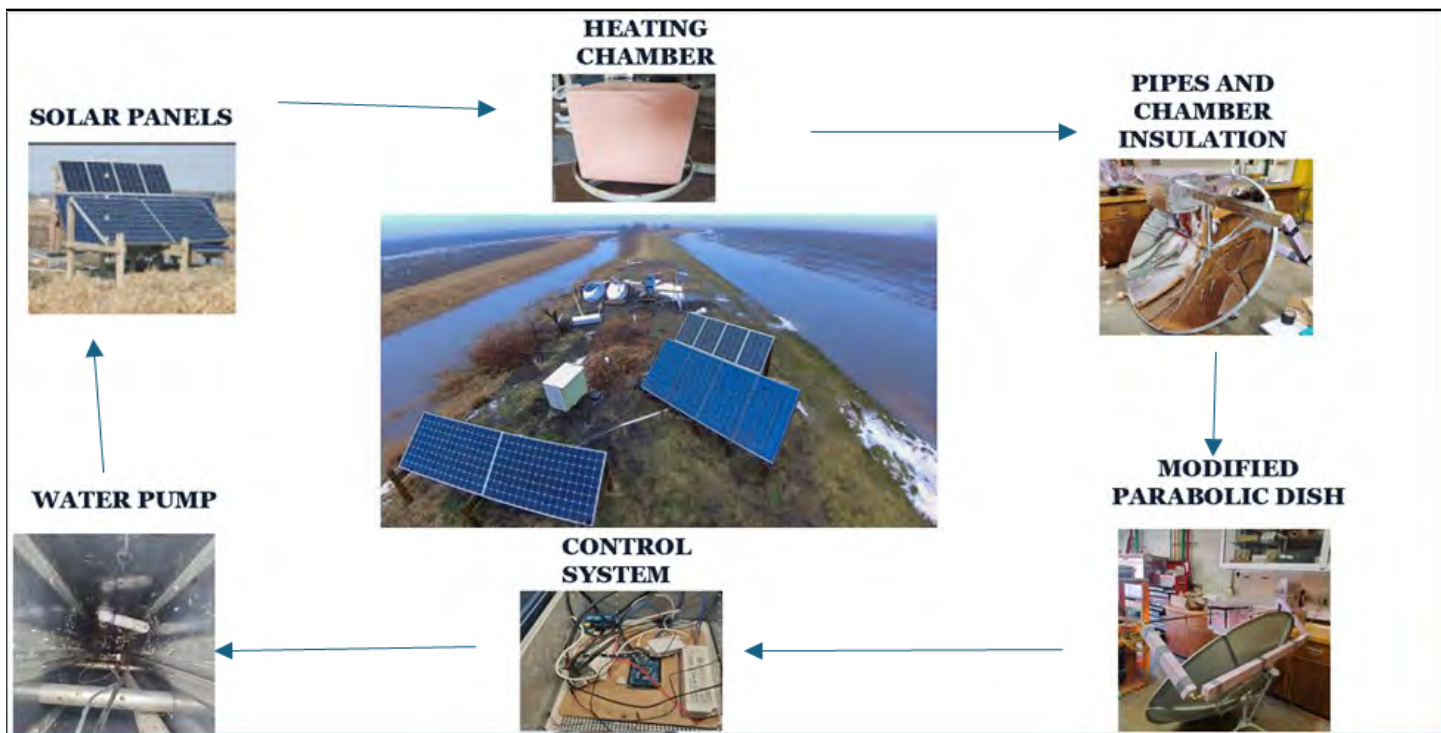

Figure 2. Elements of the heated bioreactor installation.

the water temperature in the bioreactor at 15°C (60°F). This cap is adjustable. Pictures of several elements of the system are shown in Figure 2.

Figure 3 shows an example of the relationship between temperature and nitrate removal rate in a bioreactor. At the South Farm installation, the bioreactor water temperature fluctuates. It averages approximately 10°C (50°F) and does not go below 5°C (41°F). If the temperature is increased from 10°C to 20°C the nitrate removal rate would more than double.

A simulation model was used to estimate the effect of increasing the average temperature in the South Farm bioreactor. The model estimates that the annual nitrate load removal would be increased from 4.1 lbs/acre/year to 7.5 lbs/acre/year or 11 lbs/acre/year, respectively, if the bioreactor water temperature were increased to 15°C (59°F) or 20°C (60°F), as shown in Figure 4.

The experiment will be conducted for two years. Over this period, the actual performance of the system, and the cost of cost/benefit ration of the system will be determined.

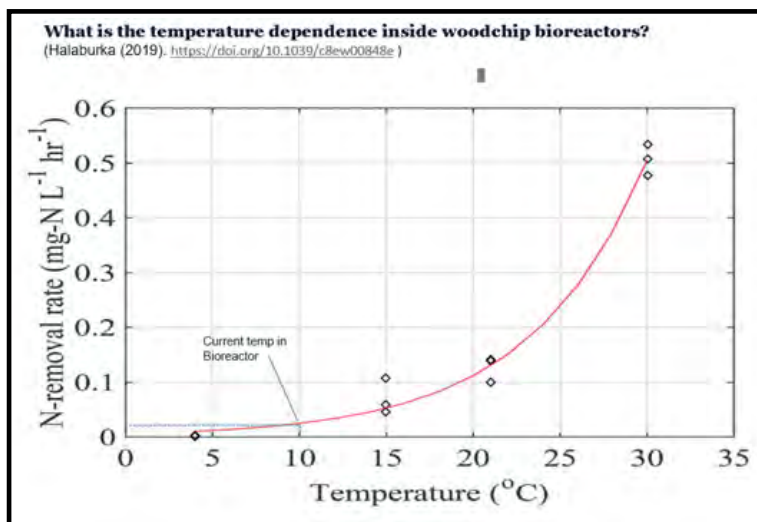

Figure 3. Nitrate removal rates plotted against.

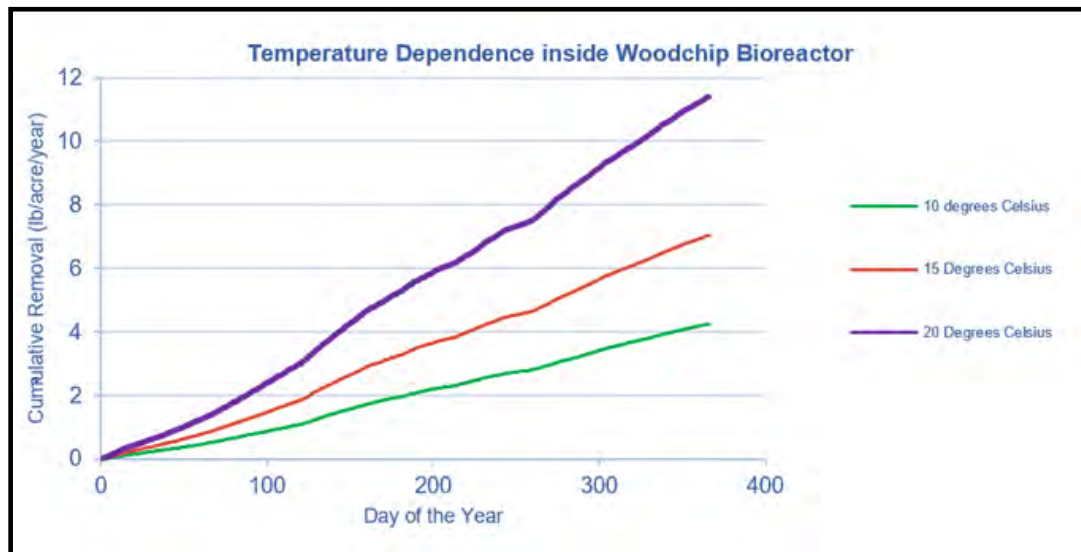

Figure 4. Simulated cumulative removal of nitrate at different mean temperatures in the South Farm bioreactors.

ILICA ANNUAL CONVENTION TIPS THE HAT TO IOWA

Testing our luck one more time over the river, the ILICA Annual Convention and Members' Meeting was held on February 1-3 at the Isle Casino Hotel in Bettendorf, Iowa. Despite the quizzical looks many attendees likely received from folks when they told them they were traveling to Iowa for an Illinois LICA conference, the Isle Casino Hotel dealt us another extraordinary hand...or make that event rather. The venue suits our group size well, staff is great, and you cannot find better conference food. With attendee surveys indicating the same for the last two years, Illinois LICA tips its hat to Iowa as we travel back into Illinois for the 2025 Annual Convention in Champaign.

Convention registration numbers hovered around the 130 mark, with an uptick in exhibitors and double the number of trade show only registrants as compared to last year. Sponsorship for the event was once again strong thanks to our very supportive Associates, and our silent auction raised just under \$4,000. As usual, our banquet, entertainment, and hospitality were all top-notch, as was the John Deere Davenport Works Factory tour, facilitated by Martin Equipment, that kicked off the event. New this year, we brought some history onto the trade show floor with the addition of booth space for antiques and other historical relics of the industry, displayed from members' personal collections. Life member Stan Seever's shared history lessons afterhours with his collection of "Stan's What's It's." And this year's education sessions, focusing mostly around one-call safety and concerns, spurred serious industry dialogue and emphasized Illinois LICA's commitment to improving the whole one-call process from both sides of the table. We want to especially thank Mark Shortz for sharing his personal story during convention and for greatly assisting in this continued process. It's something that impacts every one of our contractors in Illinois, each and everyday.

Thank you to our Convention Committee, event sponsors, exhibitors, speakers, and everyone that showed up to support the 2024 Illinois LICA Annual Convention ...even in Iowa!



See more photos @

<https://www.illica.net/state-conventions/2024-convention>



Exhibitors & Sponsors

Advanced Drainage Systems	J.U.L.I.E.
Agri Drain Corporation	Marathon Pipe Line
Altorfer CAT	Martin Equipment of Illinois, Inc.
Ameren Illinois	Maurer-Stutz, Inc.
Berns, Clancy, & Associates	Metal Culverts, Inc.
BigIron	Mid America Trenchers, LLC
Birkey's	Mid-Tech Services, Inc.
BRON	Northland Trenching Equipment
Cen-Pe-Co Lubricants	Pinion
Central Plastic Products	Port Industries, Inc.
Consolidated Treatment Sys.	Precision Intakes, Ltd.
Cook's AGPS, LLC	Prins Insurance, Inc.
Dimond Bros Insurance	Prinsco, Inc.
Empty Pockets Rebuilds	Purple Wave Auction
Envision Insurance Group, LLC	River Valley Pipe, LLC
FleetWatcher	Schlatter's, Inc.
Fratco, Inc.	Springfield Plastics, Inc.
Grey & Associates	The Wetlands Initiative
Hickenbottom, Inc.	United Fire Group
HyPro Equipment	Vermeer Midwest, Inc.
Jim Hawk Truck Trailers	Wolfe Heavy Equipment



2023 ILICA AWARD RECIPIENTS

During the 2024 ILICA Annual Convention held in February, the Awards Committee recognized the most outstanding individuals and partners for their contributions to ILICA in 2023. Based on membership nominations, the award winners were:

Merit Awards

For their outstanding role in support of ILICA's 2023 field demonstrations at Illinois Central College and the Farm Progress Show, Mid America Trenchers received a Merit Award.

For over 6 days, collectively, in August, Mid America Trenchers stepped up to donate equipment, employees, and expertise to a busy drainage demonstration month for Illinois LICA. Their contributions enabled Illinois LICA to complete these projects for partners on time, on budget, and safely. Beyond supporting Illinois LICA and our partners directly, these contributions also have meaningful impacts on the advancement of ag and the drainage industry through the education and research opportunities they provide; something we often forget to fully consider when the equipment and our volunteers leave the demonstration site.

Armando Alanis, Dean Drainage, received a merit award for his contributions to the same ILICA drainage project demonstrations last August held at Illinois Central College and the Farm Progress Show. Officially becoming an ILICA Affiliate member just this past spring, he has been, and continues to be, a regular and willing volunteer at ILICA's summer field demonstrations. With all the moving parts associated with these field days, Armando is always someone you can count on to jump in on any aspect of the project to get it addressed without question, and his upbeat personality makes him a friend in the field for any volunteer to work alongside.

For her exceptional contributions to Illinois LICA and for her professional advancement of the Association, Michelle Gillespie, Illinois LICA, received a merit award.



Merit Award:
Michelle Gillespie (L) receiving congratulations from Steve Anderson, Awards Comm. Chair



Merit Award:
Justin Brown (R), Mid America Trenchers, receiving award from Brian Brooks, Awards Comm. Member



Merit Award:
Armando Alanis (R) receiving award from Brian Brooks, Awards Comm. Member

If you've ever attended a National LICA meeting, you may have heard the term "bleeds green" referencing a member's commitment and passion for LICA. While it's our assumption her blood was red (or blue) before joining ILICA 4 years ago, there's no mistaking it's green now! From a friendly voice on the phone addressing membership questions to serving as graphic designer and social media guru and from single handedly streamlining event registration desks to keeping our Executive Director on task and up to speed, chances are you've dealt with Michelle, who often times serves as the first point of contact for Illinois LICA, and have been instantly struck by her professionalism, competency, and efficiency. And while the behind-the-scenes work of any organization often times goes unrecognized, there's a good possibility you started to notice things when Michelle joined the ranks of Illinois LICA. With as much passion and drive for the organization as any ILICA member, she has embraced our great Association and commits so much to expand and drive it to the next level each and every day.

Shiny Shovel Awards



Shiny Shovel Award:
Brian Obery (L; left image) & Tom Beyers (L; right image) receiving congratulations from Steve Anderson, Awards Comm. Chair

Bringing recognition to those members and partners that have consistently supported Illinois LICA in every, or almost every, event throughout the year (i.e. financially, physically, and promotionally), Shiny Shovel Award recipients are highly engaged, supporting ILICA at its numerous functions held each year. Metaphorically, their shovel never sets down long enough to acquire rust, but instead is shiny from its continual use.

Blessed with many dedicated and committed members, Illinois LICA is a very active chapter and in 2023 held 6 business

2023 ILICA AWARD RECIPIENTS (CONT.)

meetings, 2 golf outings & trap shoots, a member picnic & backhoe rodeo, 3 summer demonstration projects, countless conference calls & industry partner meetings, and an annual meeting, just to name a few.

For an individual to provide financial, physical, and promotional support to all, or even most, of these events is a notable recognition for someone who receives no monetary compensation for their dedication, commitment nor time donated to the Association. And yet, Brian Obery and Tom Beyers earned the recognition for devoting their personal time, finances, man-power, and experiences to many or most of these activities listed for 2023.

Leadership Award

By dictionary standards, “leadership” is the action of leading a group or organization. In practice, leadership is the art of motivating a group of people toward a common goal. Over the years, ILICA has benefited from the exemplary leadership & mentorship of several members, and this year Jon Seevers was recognized with the Illinois LICA Leadership Award.



Leadership Award:
Jon Seevers (R) receiving award from Brian Brooks, Awards Comm. Member

For consideration of the ILICA Leadership Award, nominees are judged on their dedication and loyalism to the Association; their willingness to share and impart their knowledge and expertise upon others within and outside of the Association; and their professionalism, business ethics, and ideological representation of the construction industry.

Jon Seevers personifies all of the above and, over the years, has led the association by serving on several committees and chairing a number of these; serving as a Director on the Board in his area for many years; serving as Vice President; and serving on committees at the National level, where he has been or is currently serving as chair for one or more of them.

A member since 1984, Jon has been a leader in Illinois LICA for over 40 years, though his family-ties within the Association run much deeper, and he has personally received numerous Merit Awards, the Shiny Shovel Award, and the Mr. Contractor Award in 2015.

Innovator Award

The Innovator Award recognizes individuals that stand out for their visionary or trendsetting contributions to conservation. Innovator award recipients are highly aware of their conservation responsibility as a landowner, partner, or ILICA member. They are strong conservation supporters and promoters that are “early

adopters” or innovators actively involved in the betterment of the conservation industry. They recognize the value of partnership and are willing to work with various interests for the optimization of resources and conservation promotion.

The 2023 Innovator Award was received by LaVerne Weber, Grade Solutions, for leveraging his geotechnical passion and expertise to find water management solutions for a diverse list of clients from commercial food & beverage processors to HOAs to farmers. While water management services now comprise a majority of his business, his company also offers site development & road construction. In fact, prior to founding his current company, LaVerne was part owner of a fly ash company during the early days of the product’s beneficial introduction into the pavement industry.

Today, his innovation runs deep and is evident in all the projects he develops and the materials he tests, or even develops himself, for quality control, such as the custom water control structures he builds for his subsurface irrigation and water reuse systems that utilize commercial wash water from food & beverage processing facilities for ag production. LaVerne serves on his local HOA’s Lake Commission and works diligently to improve the water quality of the lake through the education of landowners, water testing, and installation of water quality practices such as bioreactors. Many of these bioreactor systems are alternate designs he is developing and working on with researchers for practicality and improved efficiencies, including in-ditch, surface flow bioreactors and raised bed bioreactors. One of his current projects involves working with a local community college to develop a facility for the ag department that has several research plots with subsurface irrigation that will be plumbed through their education building to utilize a city water source and to allow for fertigation. And to give you a sense of LaVerne’s passion for innovation, he might be the only person you know that uses grade control and a GPS design with a rubber tire dozer to maximize outdoor silage storage piles for a client, which not only creates the prettiest silage pile you’ve ever seen but also actually significantly increases the feed

quality for the livestock producer.

His company’s motto, “We exist to serve others and achieve ‘Grandeur Visions’ that have long term ripple effects reaching beyond ourselves,” speaks for itself and is reflected in everything LaVerne does.



Innovator Award:
Susan & LaVerne Weber (L) receiving congratulations from Steve Anderson, Awards Comm. Chair

2023 ILICA AWARD RECIPIENTS (CONT.)

Most Active New Member

To commend and recognize the newest members of Illinois LICA that immediately immerse themselves into the goings-on of the Association, whether for their own benefit, the benefit of the Association, or both, the Awards Committee developed a new award this year called the “Most Active New Member.”

Eligible recipients must be an approved new member during the calendar year, or prior year, for which the award is presented, and they must have regularly engaged, supported, or contributed significantly to the endeavors of Illinois LICA during their first year of membership.

No stranger to being a member and serving in leadership roles within other organizations, the Most Active Member Award winner, Theodore Graff, Broken Ground Excavating, jumped right in with Illinois LICA in 2023, both figuratively and literally. Joining the Association shortly before convention one year ago, at the recommendation of his father, Theodore started building friendships and his knowledge base in tandem within ILICA right out of the gate. Sometimes popping up on his motorcycle, he was found at convention and in education sessions; he was at the picnic; he competed in the backhoe rodeo; and he supported both of our large summer field demonstrations where he was no stranger to being in the hole. And even though that is typically where we all tend to stick the new guy, we promise Theodore opted to jumping right in of his own will. In the middle of one of these demos this summer, he even obtained his certification during ILICA’s OSHA Trench Safety-Competent Person training. Frankly, we’re guessing the only reason we didn’t see him at our remaining events for the year, namely the golf outings and board meetings, is because he doesn’t much care for golf and because we haven’t yet made him a board member!



Most Active New Member Award:
Theodore Graff (R) receiving award from Brian Brooks, Awards Comm. Member

Mr. Contractor Award



Mr. Contractor Award:
Earl Mast (L) receiving congratulations from Steve Anderson, Awards Comm. Chair

Before becoming a contractor, the 2023 Mr. Contractor, Earl Mast, Mast Tiling Service, was a service technician at a local John Deere dealer for 18 years. Actively involved in his family’s farming operation, Earl got into the tiling business with family back in May 1997. Currently, with the help of his son Eric, and other family and seasonal employees as needed, his company mostly maintains, repairs,

and installs field tile drainage systems and NRCS & SWCD practices. Known for his quality of work and problem-solving skills when it comes to fixing old tiles and integrating new systems, his company primarily operates with a Hydra Max 2600 trencher, a couple Bobcat mini excavators and a Deere 200 C LC excavator.

Earl hosts field days for John Wood community college classes and for Payson High School FFA students. He has also assisted with several soil judging events.

Earl is a lifelong member of St Anthony Catholic church in Quincy, helping with their annual picnic, and he spends a lot of time with his grandkids, attending sporting events and more.



SEPTIC TRAINING VIRTUAL

Contractor Training Store and Illinois LICA will host a Virtual Septic Training Series offering 3 CEU's required for the renewal of Illinois Septic Licenses (Installer, Pumper, and Sanitation Technician)!

MARCH 28, 2024

Register Here
(ilica.net/events)

- 1 License Training: \$75
- 2 License Training: \$105
- 3 License Training: \$135

4% convenience fee applies

ILICA Members, contact the office for **\$25 member discount code**
Limited to the first 100 registrants | No refunds | No partial credits



BERNS, CLANCY AND ASSOCIATES

ENGINEERS • SURVEYORS • PLANNERS

WEB: www.bernsclancy.com

405 EAST MAIN STREET POST OFFICE BOX 755 URBANA, ILLINOIS 61803-0755 PHONE: 217 - 384 - 1144 FAX: 217 - 384 - 3355	101 THORNTON BUILDING 28 WEST NORTH STREET DANVILLE, ILLINOIS 61832-5729 PHONE: 217 - 431 - 1144 FAX: 217 - 431 - 2929
--	--



Scan to see our commitment to supporting Illinois contractors.

We keep business flowing.

With historically high prices for corn and soybeans, there has never been a better time to reinvest in land. Together with drainage contractors across Illinois, ADS products and solutions help farmers improve yields, increase farmable acres and create sustainable water management solutions to ensure the long-term success of their operation.

ADS®, the ADS logo and the Green Stripe are registered trademarks of Advanced Drainage Systems, Inc.
© 2021 Advanced Drainage Systems, Inc. 03/21

///ADS[™]
Our reason is water.[™]

CHANGE PROMULGATED AT NATIONAL LICA CONVENTION

The well-attended National LICA Winter Convention held mid-February at Virginia Beach, VA brought together contractors, associates, leadership, and their families to the chilly east coast for what LICA does best: fun & business. The unifying concept from the event was change, promulgated not only through committee meetings but also through some big announcements for the organization.

One of these announcements was the retirement of LICA's longtime Executive Director, Eileen Levy. After serving the Association for 40 years, it is safe to say "Mother LICA," as she has affectionately become known, has been witness to a number of changes within the organization and the construction industry during her tenure. Often serving as what could only be described as part-historian, Eileen has been the continuity of LICA, guiding the organization gently through countless leadership changes, benefits come-and-gone, and membership cycles. She will be missed for her contributions, her voice of reason, and her friendship at LICA, but we cannot deny her from working on that next "chapter." We wish her the very best in her well-earned retirement and future endeavors!

Another significant announcement coming out of convention was the founding of two new state chapters of LICA in Texas & Tennessee! Leading this charge are Jimmy Bynum & Janna Eggenschwiler with Garde Solutions who bring their experience with risk management solutions for the equipment manufacturing sector to the table. Both were on-hand throughout convention to meet members and learn about the inner workings of state chapters and the organization as a whole. We welcome them and look forward to working with our newest chapters as they grow!

Besides the obvious changes that will come with staff retirements and the founding of additional state chapters, there was a definitive message resonating throughout the committee meetings, education sessions, and in the hallways. It was the realization and acceptance of the willingness to change. Promulgated throughout the event from discussions on membership growth to training on suicide prevention, LICA recognized that change is a necessary requirement of any organization. Be it mandated by cultural shifts, demographic changes, wavering interests, technology, or nature, quite literally nothing stays the same forever. And while we've all heard the quote from Heraclitus, "The only constant in life is change," the other constant in life could arguably be the fear of change. Around for over 70 years, LICA is no stranger to change and has adjusted its course from time to time, but it

was evident on the beaches of the Atlantic Ocean in February that there is a renewed passion for change (and polar plunging apparently?) to ensure the continued growth and success of the organization. So, embrace the concept, the movement, and the new initiatives you see coming from LICA in the near future; they are in the organization's best interest.

Other exciting news from national convention includes the \$14,000 donation to LICA from BigIron's LICA Focus Auctions and the raising of over \$8,000 for the LICA Educational Foundation for Veterans via an impromptu challenge! Somewhat jokingly during a group address at the beginning of the convention, National LICA President David Gallahan mentioned to members that LICA will be hosting a polar plunge to raise funds for the foundation later that day. After the unsuspecting chuckles subsided, discussions about the idea swelled; members were coerced, against their better judgement; plans and times were set in motion; and next thing you know, challenged LICA contractors' reputations were on the line. Nearly 30 members took the plunge in 30 degree windchills wearing their freshly purchased swimwear from the surf shops across the street, raising funds for the foundation and revitalizing members' bodies.

All the reports and meeting minutes from the National LICA Winter Convention can be viewed on National's website at <https://www.licanational.com/meeting-minutes/> or by contacting the National office.

With intentional changes on the horizon for LICA, we hope to see you and gather your thoughts at the National LICA Summer Meeting on July 9-13 in Pittsburg, PA!





YOUR CONSTRUCTION INSURANCE PARTNERS



Dimond Bros.
INSURANCE | Est. 1867

Peru
1701 4th St.
Peru, IL 61354
815-223-7923

Fairbury
310 S. 7th St.
Fairbury, IL 61739
815-692-2343

DimondBros.com

ILICA Trivia

Where did Ron Schlatter find the watermelon he's eating during the 2006 Conservation Expo?



Be the first to submit the correct answer to michelle@illica.net
One lucky winner will receive a prize!



Jan/Feb Answer: Jean Brokish

CALENDAR OF EVENTS

Illinois

Board of Directors Meeting March 9, 2024

Museum of the Grand Prairie
950 N Lombard St, Mahomet, IL 61853

Committee Meetings: 8 am - 12 pm
Board Orientation Training: 12:30 pm
Board Meeting: 1 pm

Contractor Training Store & Illinois LICA Virtual Septic Training March 28, 2024

8 - 11:30 am

Register via QR on page 18 or at:
<https://form.jotform.com/210405973758159>

NRCS/ILICA Technical Meeting April 5, 2024

USDA-NRCS Illinois State Office
2118 W. Park Court, Champaign, IL 61821

Meeting: 9:30 am

Register to attend (members only) and/or submit
questions and comments for the meeting by March 25
at: <https://form.jotform.com/230454081861150>

ADVERTISER INDEX

Advanced Drainage Systems, Inc.	19
Agri Drain Corp	8
Berns, Clancy & Associates	18
Bradford Supply Company	11
BRON	25
Cook’s AGPS, LLC	25
Dimond Bros. Insurance., LLC	22
Drain Tile Safety Coalition	27
Envision Insurance Group, LLC	28
Fratco, Inc	7
Hickenbottom, Inc	2
Martin Equipment of Illinois, Inc	28
Maurer-Stutz, Inc	23
Metal Culverts, Inc	10
Northland Trenching Equipment, LLC	3
Port Industries, Inc.	10
Precision Intakes, Ltd	25
Prins Insurance, Inc./United Fire Group	28
Prinsco, Inc	28
Roland Machinery Co.	11
Schlatter’s, Inc.	2
Springfield Plastics, Inc.	2
Vermeer Midwest, Inc.	10
Water Management Solutions, LLC	10
Xylem, LTD.	11

**DRAINAGE & CONSERVATION
ENGINEERING SERVICES**

- State and Federal Permitting Assistance
- Familiarity with NRCS Conservation Practice Standards
- NRCS Technical Service Provider (TSP)

Contact Gayle Baker, PE
309.693.7615



3116 North Dries Ln Suite #100 Peoria, IL 61604 www.mstutz.com

FEATURED LICA BENEFIT: SPECIAL BIGIRON MEMBER AUCTIONS

LICA MEMBER AUCTION BENEFIT WITH **BIGIRON**

BigIron is renowned as one of the most reliable names in the online auction industry. For more than four decades, we've reinvented the way equipment is sold through online auctions - selling tens of thousands of items weekly to registered bidders representing a national marketplace.

Through our comprehensive online platform, you will gain the advantage of national exposure to a broad customer base, while still benefiting from local BigIron service and support.

LICA MEMBER BENEFITS

- (4) scheduled LICA Member auction dates
- Special Member rates with no added fees
- Easy access to LICA auction equipment inventory
- Additional marketing with no added fees
- Full service - we handle everything
- Ask about Member special event dedicated auction day

BigIron

BIGIRON.COM
800.937.3558



LICA FOCUS AUCTIONS

DECEMBER 2023

MARCH 2024

JUNE 2024

SEPTEMBER 2024

For additional Member benefit information

CONTACT TIM KIPPER
402.802.5028

BRON

POWER TO PERFORM

www.rwfbron.com

- Five Core Cooling System exceeds cooling for Tier 4 engine standards
- Quieter Reconfigured Cab Interior for Operator comfort
- Standard DL 850 Drainage Plow increased strength & durability
- LED Light Package for increased visibility for those long days in the field
- Improved swing mechanism for the Onboard Reel for smoother reel speeds & consistent torque
- Optional hydraulic rear step raises out of the way when plowing and lowers when required.
- Standard oscillating track frames.



BRON 585

SELF-PROPELLED DRAINAGE PLOW

AUTO STEER READY | LOW GROUND PRESSURE
CAT OR CUMMINS ENGINE

DEDICATED TO
SERVING OUR
CUSTOMERS

COOK'S

//AGPS LLC

YOUR CONTINUED SOURCE FOR:

//AGPS



GeoLogic
Computer Systems

INDUSTRY LEADING FINE GRADE RTK GPS
MACHINE CONTROL SYSTEMS





Design and machine control for tile drainage, land leveling and surface water management needs.

GPS-GNSS RECEIVERS & ANTENNAS

Announcing our newest NovAtel receivers are able to use GALILEO satellites for better availability near obstructions like trees.

ASK US HOW YOU CAN SAVE TIME SURVEYING
LESS WITH OUR LIDAR DATA PREP SERVICES

Contact Nate at 989-640-2347 or nate@cookswms.com
Visit our new website at www.cooksagps.com

PRECISION

INTAKES

2064 Republic Ave • Monroe, IA 50170

SURFACE WATER

INTAKES

- 6"-8"-10" SIZING
- HIGHLY ADJUSTABLE
- INTERCHANGEABLE
- USER FRIENDLY
- EXCLUSIVE TWIST LOCK DESIGN



800-932-7611

OFFICE@PRECISIONINTAKES.COM

"Dealer Inquiries Welcome"

www.precisionintakes.com

SAFETY FEATURE: DEFENSIVE DRIVING TIPS

Being a defensive driver entails utilizing various road skills to defend yourself against potential accident hazards. Using proper defensive driving techniques will help keep both you and other drivers safe on the road. With this in mind, be sure to implement the following defensive driving guidance the next time you get behind the wheel.



- **Eliminate distractions.** The first step in being a defensive driver is to reduce distractions while you drive. As such, it’s important to make sure the road is your sole focus—avoid using your cellphone, adjusting the radio, programming your GPS, eating, drinking or applying makeup behind the wheel.
- **Remain alert.** In addition to eliminating distractions, it’s vital to be fully aware of your surroundings on the road. This practice will help you better detect upcoming hazards, allowing you to respond as quickly and safely as possible. Check your mirrors often, and try to scan road conditions approximately 20 to 30 seconds ahead of you. Specifically, keep an eye out for other drivers, nearby pedestrians and road obstructions (e.g., traffic cones or construction work).
- **Follow the rules of the road.** This includes wearing your seat belt, obeying speed limits, using your turn signals and avoiding driving with excess passengers in your vehicle. Also, make sure you approach intersections with caution—never run a red light or stop sign. Even if you have the right of way, look around to confirm it’s safe to cross the intersection before doing so.
- **Avoid aggressive driving (and drivers).** Aggressive habits—such as switching lanes frequently, braking or accelerating suddenly, and tailgating other drivers—can increase your likelihood of being involved in an accident. Try to be as predictable and forgiving as possible by always leaving at least a four-second distance between you and the vehicle in front of you, avoiding abrupt lane changes and keeping a steady pace. If another driver is displaying aggressive habits, try to distance yourself from them or pull over when it is safe to do so.
- **Be extra careful in adverse conditions.** In severe weather (e.g., heavy rain, snow and fog), road conditions can be significantly more dangerous. Take additional precautions by reducing your speed, increasing your following distance, braking earlier and using your headlights.

Discussion Date: _____

Employee Participants

Don’t Forget to Take Care of Your Vehicle

Even the most defensive drivers could contribute to an accident on the road if operating an unsafe vehicle. Make sure you keep your vehicle in good shape by taking it for routine oil changes and fluid checks, ensuring the tires are properly inflated and performing other maintenance as needed. For additional driving safety tips and auto insurance solutions, contact us today.

IT HAPPENED TO HIM. IT COULD HAPPEN TO YOU.



FARM SAFE 811

Always **Contact 811** or clickbeforeyoudig.com before starting any drain tile project.

Watch online at ThreeSecondsLater.org



SCAN ME

Watch the award-winning, first-person account of a tragic drain tile accident and its impact on a close-knit community.

People you can
trust



the Prinsco difference
service led by values



Find a sales rep to experience the Prinsco Difference.
prinsco.com/agsales
800.992.1725

certified
WBENC



STRONG SERVICE.
POWERFUL EQUIPMENT.
ENDLESS DEDICATION.

In addition to selling industry-leading equipment for every customer need, Martin Equipment is a proud member of the Illinois chapter of the Land Improvement Contractors Association. Together, we share dialogues, connections, and education to improve the construction business and environment.



Connect and learn more at
MartinEquipment.com

IL: Goodfield, Peru, Springfield, Rock Island, and Tolono
IA: Cedar Rapids and Dubuque MO: Columbia and Palmyra



ENVISION
INSURANCE GROUP

Four Area Locations to Serve You

1616 W Pioneer Parkway
Peoria, IL 61615
(309) 683-1100

150 B, S Main St.
Morton, IL 61550

456 E Main St.
Galesburg, IL 61401

1150 E. Pershing Rd
Decatur, IL 62526

Business & Personal Insurance • Life & Health • Benefits • Bonding

INSURANCE ELEVATED.
BEYOND DEDICATED.
WE'RE ALL IN.

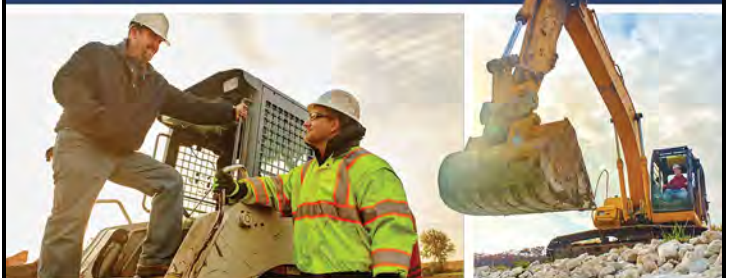

You've worked hard to construct a reliable business.

We're trusted partners equally committed to protecting your business and reputation.

Visit ufginsurance.com to find an agent today.



© 2022 United Fire & Casualty Company. All rights reserved.